

## INSTALLATION MANUAL

### **MODEL: DCF-1**

Zinwell Digital Channel Filter

---

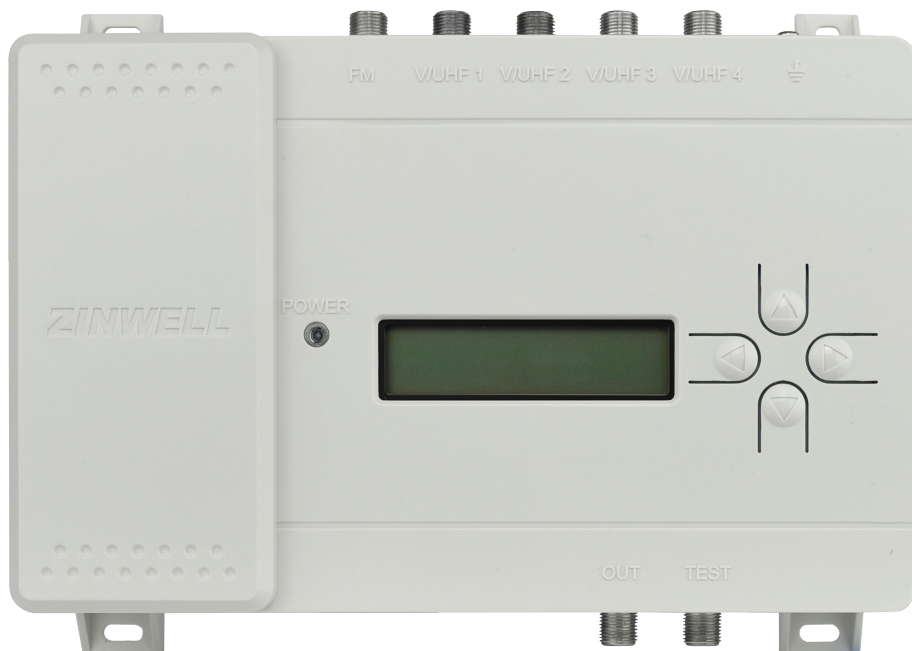

## 1. INTRODUCTION

---

Zinwell's Digital Channel Filter is an all-in-one programmable terrestrial TV signal booster, filter, combiner, channel converter, equalizer and amplifier. It is suitable for collective antenna application where terrestrial TV signals can be selected, processed, filtered, combined, equalized and amplified at once.

With embedded LCD and key pad, it is very flexible in the field for instant adjustment of channels and output power level to successfully distribute the signals within a multi-dwelling building.

## HIGHLIGHTS

---

1. 32 capture bands to select and convert terrestrial TV channels.
2. Integrated Pre-Amplifier and Automatic Gain Control (AGC) to capture and compensate incoming signal level difference.
3. 4 inputs to select the best signal from each VHF/UHF optimized antennas.
4. Automatic LTE filter selection to minimize 4G signal interference.
5. Adjustable output level up to 113 dB $\mu$ V to extend the signal coverage.
6. Intuitive key pad programming with LCD display for output signal level adjustment and channel conversion.
7. Hands on configuration with Android APP.

## 2. QUICK GUIDE

---

### 2.1 Package Content:

- a. DCF-1, Power Adaptor (mounted inside the plastic case)
- b. Power Cord
- c. OTG Cable (Micro-USB to Type-A USB)



Figure a



Figure b



Figure c

**WARNING:** User must use OTG Cable to connect Android device and DCF-1. Non OTG cable will NOT work nor shall the OTG cable be used to connect any other devices

## 2.2 Layout:

a. Dimension: 212mm (W) x 158mm (D) x 45mm (H) – **Figure 1**



**Figure 1**

b. Top Case: 1 LCD Panel, 1 set of Keypad, 1 LED Power Indicator (Blue/Red) – **Figure 3**

c. Front Panel: 1 AC Jack, 1 USB Port, 1 Output and 1 Test Output – **Figure 3**

d. Back Panel: 1 FM Input and 4 VHF/UHF Inputs – **Figure 2**



**Figure 2**

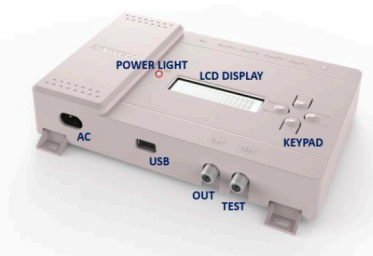

**Figure 3**

## 2.3 Installation Precautions:

DCF-1 is an indoor unit which is designed to operate in the temperature range of 0~50°C, but we highly recommend to install the device in a temperature controlled environment to ensure its optimum performance and to maximize the life span of the device.

Also, do not expose the unit to rain or moisture.

### 3. CONFIGURATION

---

DCF-1 uses LCD panel as the interface to change the settings and configuration. User can easily modify the parameters by using the buttons on DCF-1 without any other devices. However, before starting to configure, set your country first in order to load the frequency plan accordingly (see 3.2.3 Set Country).

#### 3.1 User Interface:

##### 3.1.1 LCD Display

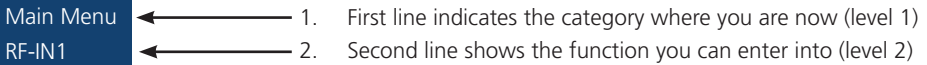

##### 3.1.2 Arrow Key

Use Arrow Key to move cursor, give order and change numbers.

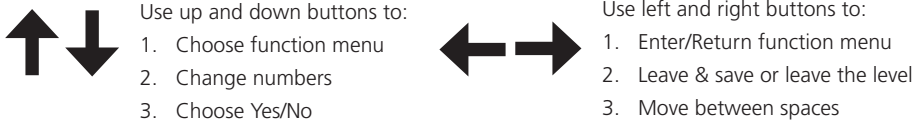

#### 3.2 Setting Instruction:

##### 3.2.1 Input (Configuration Introduction)

DCF-1 is suitable for collective antenna application with its own booster, filter, combiner, channel converter, equalizer, and amplifier. Moreover, there are 4 VHF/UHF inputs and 1 FM input in this device to receive different terrestrial TV/FM signals.

##### Pre-Amplifier

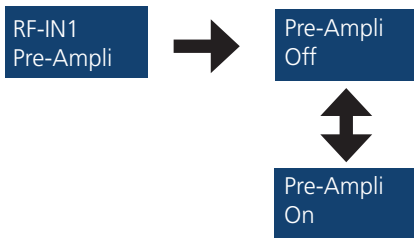

Under the level of each inputs (RF-IN1 to RF-IN4), user can choose to turn on/off the amplifier. The pre-amplifier option increases the signal power, but it also increases the system noise and may degrade the signal quality. Misusing pre-amplifier could significantly increase distortion and consequently reduce the signal quality in the output. Therefore, it is recommended to know the signal quality on the input side (gain, tilt, bandwidth and noise figure) when applying pre-amplifier to measure its impact on the output side.

**Recommendation:** Turn on the Pre-Amplifier only when the input signal level is too low (Lower than 60 dB $\mu$ V). The user may refer to the automatic input signal power level measurement when adding a channel on DCF-1.

**NOTE:** If target channel's signal level is low but other high level channels in the same band could saturate Pre-Amplifier and cause poor signal quality. Refer to all receiving channels quality to decide whether to turn on pre-amplifier or not.

## Antenna Power

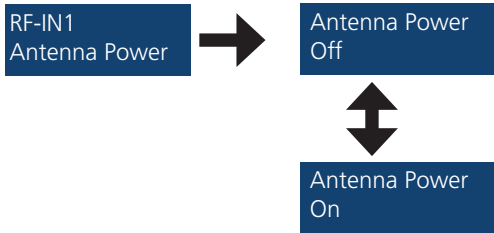

Each input port (RF-IN1 to RF-IN4) is capable of supplying 12V, 100mA (max.) to an active antenna. The user may choose to turn on/off the power on each input port based on the nature of the antenna (passive or active) of user's choice.

## Auto Scan

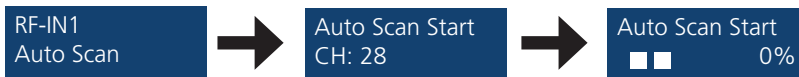

In this operation, DCF will automatically scan input channel frequency if this input channel frequency is available, DCF will add this input channel frequency at same output channel frequency. For example, input CH28 is available, DCF will add input CH28 to output CH28 (After 0% ~ 100%, it's fully scanned.)

### NOTE:

1. If input channel power level is higher than 50dBuV (-58dBm), this channel will be added to output channel list.
2. In auto scan function, when user scanning for VHF input, it will start from CH6~CH12. In the other words, when scanning UHF input, it will start from CH28~CH69.

## Add Channel

On below LCD display:

1. RF-IN1 refers to the desired signal input port. CH28 refers to input channel, 28 refers to the output channel. 50 dB $\mu$ V refers to the input signal power level (measured automatically by DCF-1).
2. Use Up/Down to change channel number, use Left/Right to choose Input/Output channel.
3. Press the Left button at Input Channel or press the Right button at Output Channel to save settings and go back to previous page.
4. To avoid signal overlapping, Output Channel number cannot be duplicated.
5. Maximum output channel numbers are 32 (RF-IN1 + RF-IN2 + RF-IN3 + RF-IN4 = Max 32)

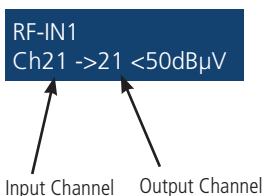

**NOTE:**

Due to automatic LTE filter selection capability of DCF-1, each input port can receive VHF or UHF band signal only. To program it, the user needs to choose an input port and associate a channel to it, and DCF-1 will automatically lock to VHF/UHF band based on the command. In above case, the user has chosen CH28 and that will lock RF-IN1 to receive UHF band signal only. By removing all the channels associated to a specific input port, the user can reprogram the input port to receive VHF/UHF band again.

**Add Channel Example:**

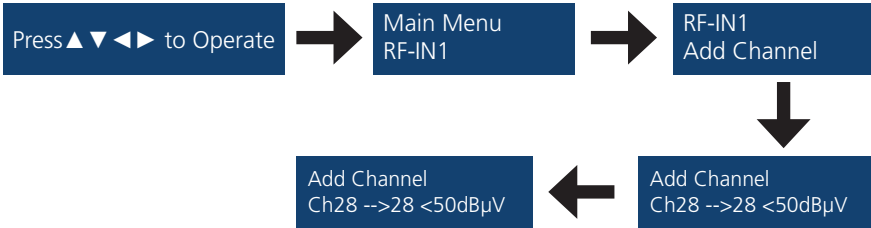

**Edit Channel:**



After adding and saving channels, the user can find the Channel List under the Input level. Press the Right key to edit channels.

**Delete Channel:**



When you are at level Edit Channel, by changing the input channel into 0 and save it, then the channel will be deleted.

### 3.2.2 FM Pre-Ampli

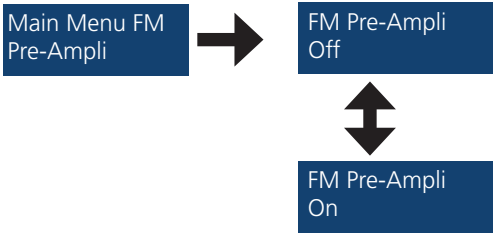

The DCF-1 gathers all the FM signals on the air and provides pre-amplifier function for it. The user may choose to turn on/off the function to have the FM signal quality. The user may refer to the automatic input signal power level measurement when adding a channel to the DCF-1.

### 3.2.3 Set Country



In this section, select the country you are currently at, and the DCF-1 will change the frequency plan accordingly. (Country options: Europe, Thailand, New Zealand, Australia, Mexico and Brazil.)

### 3.2.4 Output

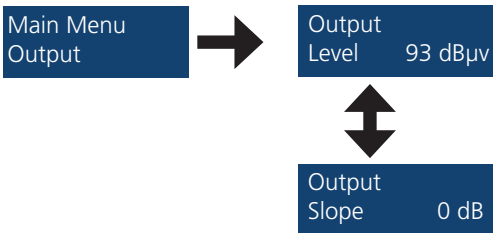

1. Output power level can be adjusted from 93 dBµV ~ 113 dBµV
2. Slope rate can be changed from 0 ~ -9 dB

The Output Level is for the total channel power, the more channels are added to the DCF-1, the lesser output power you should give to each channel.

### 3.2.5 FW Version



Above display shows the hardware, MCU and software version of the device.



### 3.2.6 Reset default

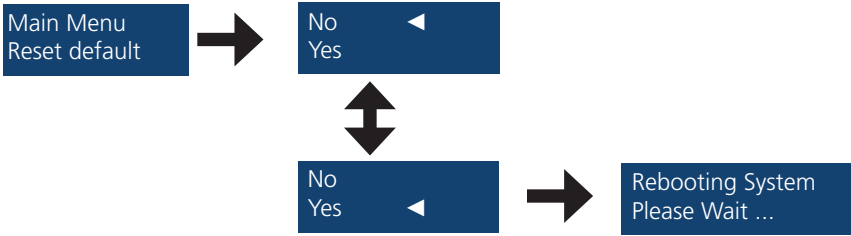

To reset the DCF-1 to default setting, please follow above steps. By doing so the DCF-1 will erase all of previous programming from the device permanently. Please note all the information within the DCF-1 will be erased with command, but the user can reload the configuration from “dcf1\_configuration.bin” file within the Download folder if setting has been saved previously.

### 3.2.7 Lock

#### Set Pin Code



Default pin code: 0000

To avoid unauthorized people changing the settings or unintended maneuver, DCF-1 can be locked with security code.

1. Use Left/Right buttons to move between numbers.
2. Use Up/Down buttons to change the code numbers.
3. When the code has been set up, use the Right button to save changes and leave this level.
4. When the cursor is on the left side, use the Left button to leave this level without any change.

#### Set Pin Code



This function is made to protect the settings, after enable this function you will have to enter password every time when you try to operate the DCF-1.

#### No Lock



The user may leave the DCF-1 without any protection by choosing above option.

### 3.2.8 LCD Timeout



Home screen will automatically turn off in 30 seconds if nothing being ordered, use any key on the key pad to awake the DCF-1. You can change the timeout setting from 30/60/90/120s.

## 4. APK USER GUIDE

---

### Requirements:

1. Android device (mobile or tablet) with Android 5.0 and above
2. OTG cable
3. DCF-1 device

### **Connecting your Android device to DCF-1:**

Connect your Android device to DCF-1 by using the OTG cable, then open the APP.

**WARNING:** User must use OTG Cable to connect Android device and DCF-1.  
Non OTG cable will NOT work nor shall the OTG cable be used to connect any other devices!

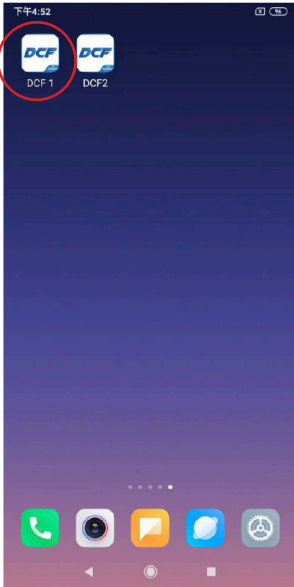

Now, you are ready to program DCF-1 by using your Android device.

## Programming DCF-1 by using your Android device:

### 1. Input Channel Setting (Add/Delete/Edit Channel):

#### a. Add channel:

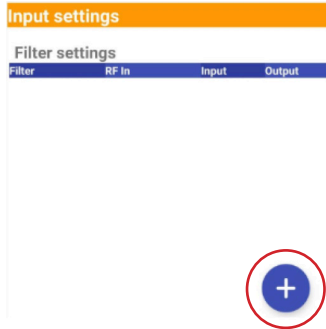

Press the + bottom here to add a new channel

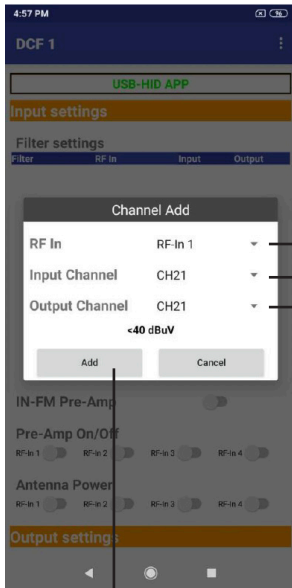

Select input port from 1~4

Select input channel

Select output channel

Add the channel

b. Delete channel:

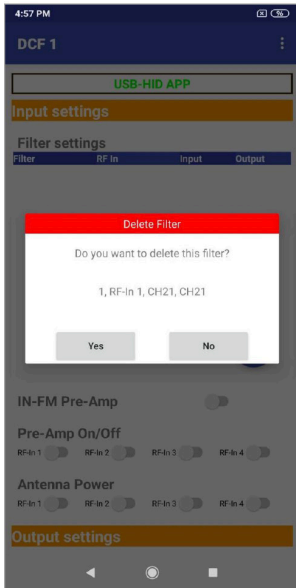
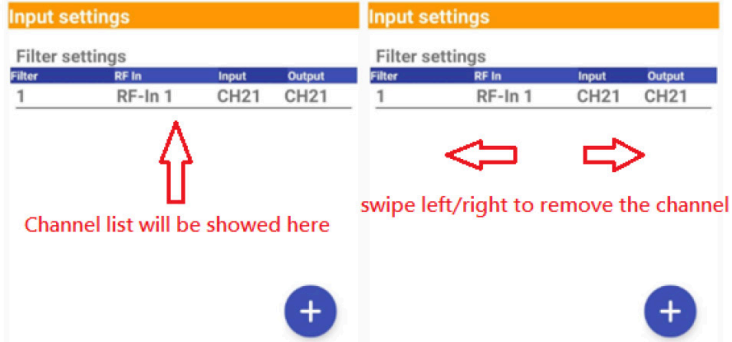

Before remove the filter, it will show up a window to ask the user whether wants to delete it.

### c. Edit Channel:

Press the channel you've set, and you will be able to edit it.

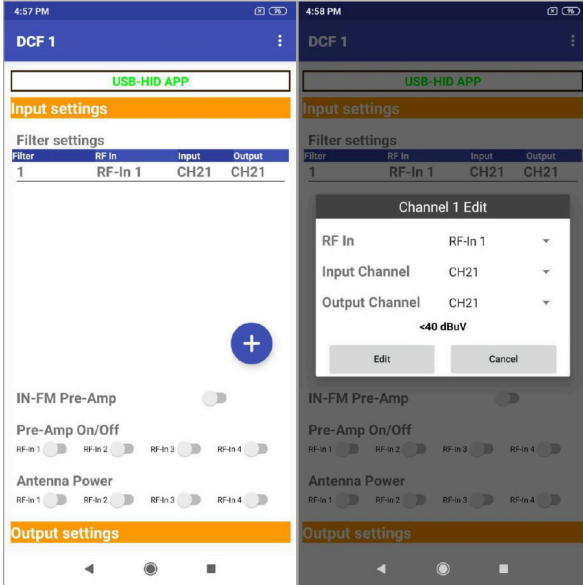

FM Pre-Amp: Turn on/off amplifier function for FM signal.

Pre-Amp On/Off: Turn on/off amplifier function for each RF-INPUTS.

Antenna Power: Turn on/off amplifier function for each Antennas. (The input ports can supply 12V, 100mA to active antennas.)

DCF-1 is an active device which amplifies signal power, but also increase the system noise and degrade signal quality. Misused amplifier could significantly increase distortion and reduce signal quality. Therefore, it is necessary to know about its gain, tilt, bandwidth, and noise figure when applying an amplifier to measure its impact in the coaxial network.

**Recommendation:** Turn on the Pre-Amplifier only when the input signal level is too low (Lower than 60 dBuV). The user may refer to the automatic input signal power level measurement when adding a channel on DCF-1.

**NOTE:** If target channel's signal level is low but other high level channels in the same band could saturate Pre-Amplifier and cause poor signal quality. Refer to all receiving channels quality to decide whether to turn on pre-amplifier or not.

## 2. Output Setting (Output Power Level/Slope):

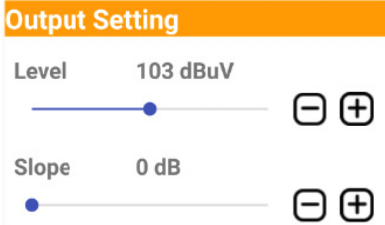

1. Output power level can be adjusted from 93 dB $\mu$ V ~ 113 dB $\mu$ V
2. Slope rate can be changed from 0 ~ -9 dB

The more channels are added to DCF-1, the lesser output power you should give to each channel.

## 3. Configuration Maintain:

### a. Software Update:

To update the software, press "OK" on Software update, then click "File Select" to choose the update file and press "OK" to start the update.

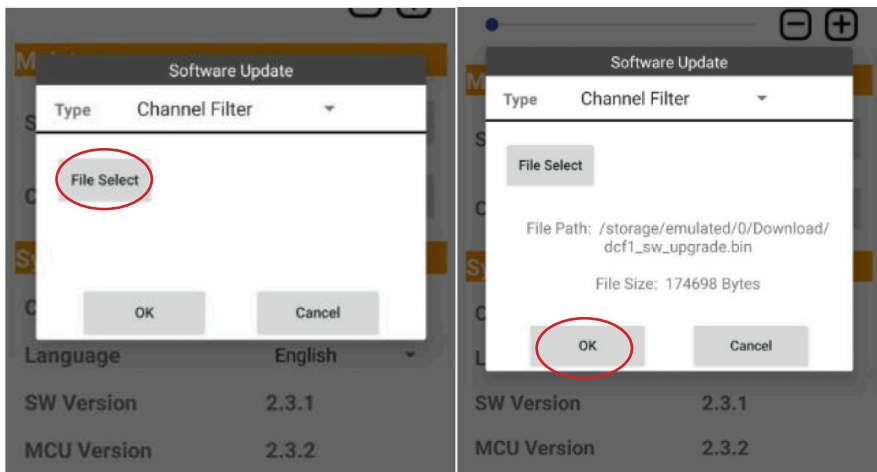
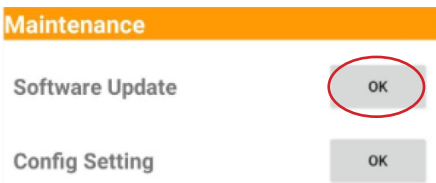

**NOTE:** In case SW upgrade is needed, the software package must be placed in the "Download" folder of your mobile device.

### b. Configuration Save/Load/Delete:

Press “Config Setting” to start saving the configuration. User can save it up to maximum 10 sets. Meanwhile, user can type the file name up to maximum 10 character. Choose “Load” can reload to the previous setting. User also can delete the file from this function.

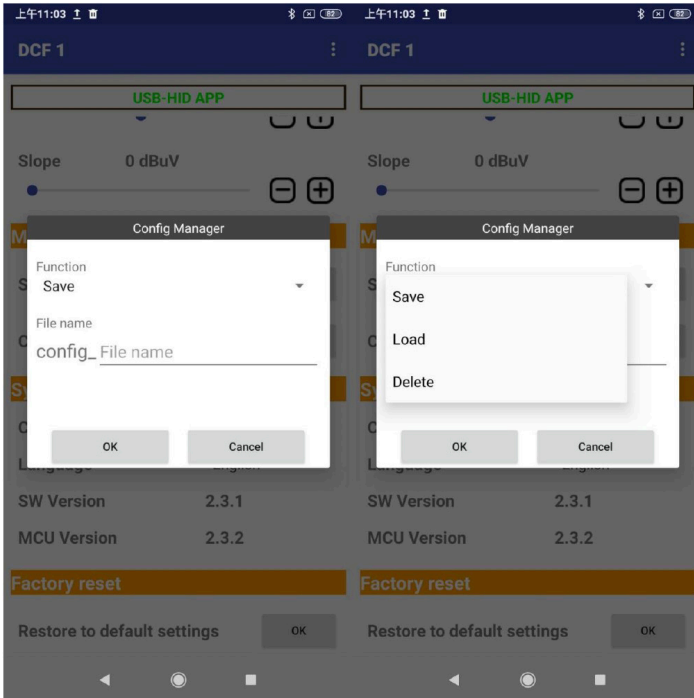

#### 4. Output Setting (Output Power Level/Slope):

This part shows the information and the version of the device. In the country section, select the country you are currently at, then the DCF-1 will change the frequency plan accordingly. (Country options: Europe, Thailand, New Zealand, Australia, Mexico and Brazil.)

System Information		
Country	EUR	▼
Language	English	▼
SW Version	2.3.1	
MCU Version	2.3.2	

#### 5. Restore Factory Default:

To reset the device to default setting, press "OK" to rest the device. Please note all the information within DCF-1 will be erased with command, but the user can reload the configuration from "Config Setting" if it has been saved previously.

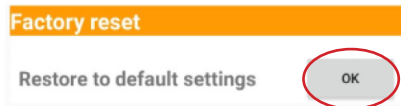



## 5. APPLICATION SCENARIO 1

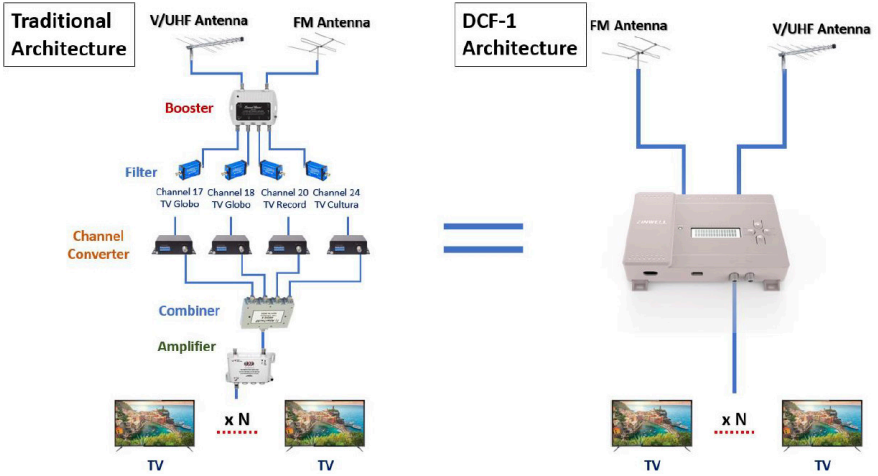

## 6. APPLICATION SCENARIO 2

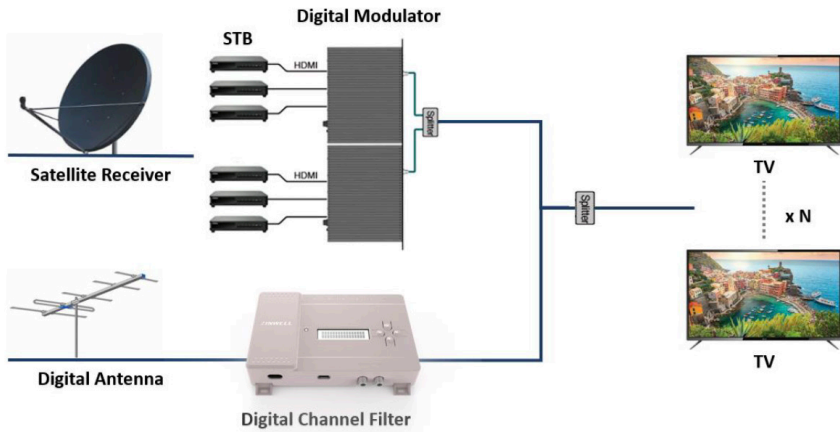

## 7. CHANNEL AND FREQUENCY LIST FOR AUSTRALIA

---

CH.	Frequency (MHz)	BW
6	177.5	7
7	184.5	7
8	191.5	7
9	198.5	7
9A	205.5	7
10	212.5	7
11	219.5	7
12	226.5	7
28	529.5	7
29	536.5	7
30	543.5	7
31	550.5	7
32	557.5	7
33	564.5	7
34	571.5	7
35	578.5	7
36	585.5	7
37	592.5	7
38	599.5	7
39	606.5	7
40	613.5	7
41	620.5	7
42	627.5	7
43	634.5	7
44	641.5	7
45	648.5	7
46	655.5	7
47	662.5	7
48	669.5	7
49	676.5	7
50	683.5	7

CH.	Frequency (MHz)	BW
51	690.5	7
52	697.5	7
53	704.5	7
54	711.5	7
55	718.5	7
56	725.5	7
57	732.5	7
58	739.5	7
59	746.5	7
60	753.5	7
61	760.5	7
62	767.5	7
63	774.5	7
64	781.5	7
65	788.5	7
66	795.5	7
68	802.5	7
68	809.5	7
69	816.5	7

## 7. CHANNEL AND FREQUENCY LIST FOR NEW ZEALAND

CH.	Frequency (MHz)	BW
26	514	8
27	522	8
28	530	8
29	538	8
30	546	8
31	554	8
32	562	8
33	570	8
34	578	8
35	586	8
36	594	8
37	602	8
38	610	8
39	618	8
40	626	8
41	634	8
42	642	8
43	650	8
44	658	8
45	666	8
46	674	8
47	682	8
48	690	8
49	698	8
50	706	8
51	714	8
52	722	8
53	730	8
54	738	8
55	746	8

CH.	Frequency (MHz)	BW
55	746	8
56	754	8
57	762	8
58	770	8
59	778	8
60	786	8
61	794	8
62	802	8
63	810	8
64	818	8
65	826	8
66	834	8
67	842	8
68	850	8
69	858	8

This warranty against defects is given by GME Pty Ltd ACN 000 346 814 (We, us, our or GME). Our contact details are set out in clause 2.7. This warranty statement only applies to products purchased in Australia. Please contact your local GME distributor for products sold outside of Australia. Local distributor details at [www.gme.net.au/export](http://www.gme.net.au/export).

**1. Consumer guarantees**

- 1.1 Our goods come with guarantees that cannot be excluded under the Australian Consumer Law. You are entitled to a replacement or refund for a major failure and for compensation for any other reasonably foreseeable loss or damage. You are also entitled to have the goods repaired or replaced if the goods fail to be of acceptable quality and the failure does not amount to a major failure.
- 1.2 To the extent we are able, we exclude all other conditions, warranties and obligations which would otherwise be implied.

**2. Warranty against defects**

- 2.1 This warranty is in addition to and does not limit, exclude or restrict your rights under the Competition and Consumer Act 2010 (Australia) or any other mandatory protection laws that may apply.
- 2.2 We warrant our goods to be free from defects in materials and workmanship for the warranty period (see warranty table) from the date of original sale (or another period we agree to in writing). Subject to our obligations under clause 1.2, we will at our option, either repair or replace goods which we are satisfied are defective. We warrant any replacement parts for the remainder of the period of warranty for the goods into which they are incorporated.
- 2.3 To the extent permitted by law, our sole liability for breach of a condition, warranty or other obligation implied by law is limited
  - a) in the case of goods we supply, to any one of the following as we decide -
    - (i) the replacement of the goods or the supply of equivalent goods;
    - (ii) the repair of the goods;
    - (iii) the cost of repairing the goods or of acquiring equivalent goods;
  - b) in the case of services we supply, to any one of the following as we decide –
    - (i) the supplying of the services again;
    - (ii) the cost of having the services supplied again.
- 2.4 For repairs outside the warranty period, we warrant our repairs to be free from defects in materials and workmanship for three months from the date of the original repair. We agree to re-repair or replace (at our option) any materials or workmanship which we are satisfied are defective.

- 2.5 We warrant that we will perform services with reasonable care and skill and agree to investigate any complaint regarding our services made in good faith. If we are satisfied that the complaint is justified, and as our sole liability to you under this warranty (to the extent permitted at law), we agree to supply those services again at no extra charge to you.
- 2.6 To make a warranty claim you must before the end of the applicable warranty period (see warranty table), at your own cost, return the goods you allege are defective, provide written details of the defect, and give us an original or copy of the sales invoice or some other evidence showing details of the transaction.
- 2.7 Send your claim to:  
**GME Pty Ltd.**  
 17 Gibbon Rd, Winston Hills,  
 NSW 2153 Australia.  
 Tel: (02) 8867 6000  
 Fax: (02) 8867 6199  
 Email: [servadmin@gme.net.au](mailto:servadmin@gme.net.au)
- 2.8 If we determine that your goods are defective, we will pay for the cost of returning the repaired or replaced goods to you, and reimburse you for your reasonable expenses of sending your warranty claim to us.

**3. What this warranty does not cover**

- 3.1 This warranty will not apply in relation to:
  - (a) goods modified or altered in any way;
  - (b) defects and damage caused by use with non GME products;
  - (c) repairs performed other than by our authorised representative;
  - (d) defects or damage resulting from misuse, accident, impact or neglect;
  - (e) goods improperly installed or used in a manner contrary to the relevant instruction manual; or
  - (f) goods where the serial number has been removed or made illegible.

**4. Warranty period**

- 4.1 We provide the following warranty on GME and Kingray products. No repair or replacement during the warranty period will renew or extend the warranty period past the period from original date of purchase.

Product Type	Warranty Period
Zirwell DCF-1	1 Year



Specialists in Digital TV Distribution Solutions

1300 463 463 [kingray.net.au](http://kingray.net.au)

A division of GME Pty Ltd.  
 Head Office: PO Box 96, Winston Hills, NSW 2153, Australia.  
 New Zealand: PO Box 58446 Botany, Auckland, 2163,  
 NZ. T: (09) 274 0955.  
 All international enquiries email: [export@gme.net.au](mailto:export@gme.net.au)

Version:  
 DNI 50354-2  
 PN: 311104